

The solid state relay solution with real-time monitoring through Modbus



Benefits

- **Fieldbus interface.** Solid state relay parameters and diagnostic data are accessible through Modbus RTU over an RS485 interface.
- **Reduced maintenance costs and downtime.** Use of real-time data for prevention of machine stoppages during operation.
- **Good quality products and low scrap rates.** Real-time monitoring allows timely decisions for better machine and processes management.
- **Reduced efforts in troubleshooting.** A number of faults can be distinguished to facilitate and reduce troubleshooting time.
- **Versatile.** Easy integration in existing machines as the control of the solid state relay does not change compared to a solid state relay without a communication interface.
- **Fast installation and set-up.** The solid state relays on the BUS are configured by AutoConfiguration for fast set-up and prevention of incorrect settings.
- **Compact dimensions.** Adopts the same compact platform of the slimline RG series with a minimum product width of 17.8mm, 1x DIN, up to 37 AAC @ 40°C.

Description

The **NRG** is a system consisting of one or more BUS chains that communicate with the main controller in the machine through Modbus RTU over an RS485 interface.

The communication interface in the **NRG** system allows read out of variables such as voltage, current, frequency, energy consumption and power of the solid state relays **RG..N** in real time. The status of the components in the NRG system is readable with an identification of the specific fault to facilitate troubleshooting. The **NRG** system is very flexible and allows the user to modify default limits to adapt to the own specific needs.

The **RG..N** solid state relays in the NRG are suitable for switching of heater loads and their switching is controlled by a DC voltage in the range of 4-32 VDC. In case of a malfunction of the communication interface, the **RG..N** switching function is not affected. The switching function is solely dictated by the presence of the control voltage.

Applications

Any heating application where reliable and precise maintenance of temperatures is crucial to the quality of the end product. Typical applications include plastic machinery such as injection machines, extrusion machines and PET blow moulding machines, packaging machinery, sterilisation machinery, drying tunnels and semiconductor manufacturing equipment.

Main function

- 1-phase AC zero cross solid state relays up to 660 VAC, 90 AAC
- 4-32 VDC control for switching of the solid state relay
- Modbus RS485 interface for real-time monitoring

The NRG system overview

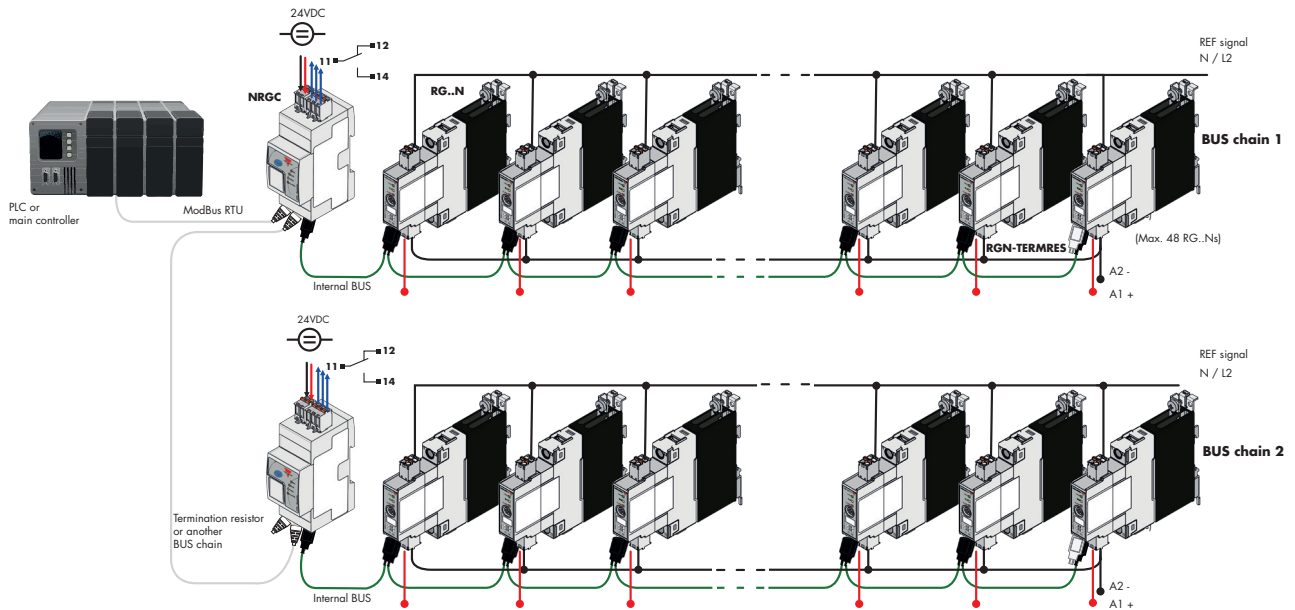

Description

The **NRG** system may consist from 1 up to a maximum of 247 BUS chains. Each BUS chain consists of 1 NRG controller, the **NRGC** and a maximum of 48 **RG..N** solid state relays. The main controller in the machine uses Modbus RTU to communicate with the respective BUS chains. Each NRGC in the system needs to be assigned a Modbus ID and hence the limitation of 247 NRGCs in the system.

The **NRGC** acts as a master of the respective BUS chain when it is requested by the main controller to carry out specific actions on the BUS chain, for example when an AutoConfiguration needs to be executed to automatically assign a valid ID to each **RG..N** on the BUS. Otherwise, the NRGC is just a facilitator of the communication between the main controller and each individual **RG..N** solid state relay in the system.

The **RG..N** solid state relays are physically linked to the NRGC through an internal BUS using proprietary cables **RCRGN-xxx-2** available at various lengths. Each **RG..N** in the NRG system needs to be uniquely identified for the main controller to be able to access its data. Great time savings are achieved since there is no need to physically set the ID of each individual **RG..N** in the system. Through an Autoconfiguration command each **RG..N** is assigned a unique ID based on its physical location on the BUS and the NRGC ID to which it is connected.

NRG system required components

Description	Component code	Notes
Solid state relays	RG..N	NRG solid state relays
NRGC controller	NRGC	NRG controller with Modbus RS485. 1x NRGC is required for every bus chain (max 48 RG..Ns) 1x RGN-TERMRES is included in the NRGC packaging. The RGN-TERMRES is to be mounted on the last RG..N on the bus chain.
NRG internal BUS cables	RCRGN-xxx	Proprietary cables terminated at both ends with a micro USB connector

List of contents

RG..N.....	4
Reference.....	5
Structure.....	6
General data.....	7
RGS output specifications.....	7
RGC output specifications.....	8
Input specifications.....	8
Internal bus.....	9
Output power dissipation.....	9
RGS heatsink selection.....	10
RGS thermal data.....	10
RGC current derating.....	11
RGC derating vs. spacing.....	11
Compatibility and conformance.....	13
Filter connection diagram.....	14
Filtering.....	14
Environmental specifications.....	15
Measurements.....	16
LED indicators.....	16
Alarm management.....	17
Short circuit protection.....	18
Dimensions.....	20
Connection diagrams.....	23
Functional diagram.....	24
Mounting.....	25
Installation.....	26
Connection specifications.....	27
NRGC.....	29
Reference.....	30
Structure.....	31
General data.....	32
Dimensions.....	32
Power supply specifications.....	32
Auxiliary relay specifications.....	33
Internal bus.....	33
Compatibility and conformance.....	34
Environmental specifications.....	35
LED indicators.....	35
Alarm management.....	36
Connection diagram.....	36
Mounting.....	37
Connection specifications.....	38
RCRGN.....	39

RG 1-phase solid state relays with a communications interface



Main features

- Zero cross switching AC solid state relay
- Rated voltage up to 660 VAC
- Rated current for RGS: 50, 90 AAC
- Rated current for RGC: 25, 30, 37, 43, 65 AAC
- Product width: 17.8 mm, up to 70 mm for RGC > 37 AAC
- Control voltage: 4-32 VDC
- I²t up to 18,000 A²s for protection with Type B Minitaure Circuit Breakers
- 100 kArms short circuit current ratings according to UL508
- LED indication for ON, BUS, ALARM status

Description

The **RG..N** solid state relays are the switching components in the NRG BUS chain. Apart from the switching function, they have integrated monitoring components and a communication interface to provide data of the monitored variables in real-time. 1 BUS chain can handle up to 48 **RG..Ns**.

The first **RG..N** in the BUS chain is connected to the **NRG** controller, **NRGC**, whilst the last **RG..N** in the BUS chain has to be terminated with a BUS terminator provided in the packaging of the **NRGC**.

The **RG..Ns** solid state relays are available either with integrated heatsink, **RGC..N** or else without heatsink, **RGS..N**. Output ratings go up to 660 VAC, 65 AAC for the **RGC..N** and 90 AAC for the **RGS..N**. Switching of the **RG..N** is controlled by a DC voltage in the range of 4-32 VDC applied through a spring pluggable terminal.

A voltage reference connection is required to enable measurement of voltage and other variables using the voltage measurement. LEDs on the front facade give a visual indication of the status of the solid state relay output, any ongoing communication and the alarm status of the solid state relay and its respective load.

Specifications are noted at 25°C unless otherwise specified.

Carlo Gavazzi compatible components

Description	Component code	Notes
NRGC controller	NRGC	NRG controller with Modbus RS485. 1x RGN-TERMRES is included in the NRGC packaging
NRG Internal BUS cables	RCRGN-010-2	10cm cable terminated at both ends with a microUSB connector. Packed x4 pcs.
	RCRGN-075-2	75cm cable terminated at both ends with a microUSB connector. Packed x1 pc.
	RCRGN-150-2	150cm cable terminated at both ends with a microUSB connector. Packed x1 pc.
	RCRGN-350-2	350cm cable terminated at both ends with a microUSB connector. Packed x1 pc.
	RCRGN-500-2	500cm cable terminated at both ends with a microUSB connector. Packed x1 pc.
Termination resistor	RGN-TERMRES	Internal BUS chain terminator. 1 pc. is included in the NRGC packaging
Plugs	RGMREF	Spring plug labelled 'Ref'. Packed x10 pcs. 1 pc. included in the RG..N packaging
	RGM25	Spring plug labelled 'A1 A2'. Packed x10 pcs. 1 pc. included in the RG..N packaging
Heatsinks	RHS...	Heatsinks for RGS models

Order code

 RG 1A60D EN

Enter the code entering the corresponding option instead of

Code	Option	Description	Notes
R	-	Solid State Relay (RG)	
G	-		
<input type="checkbox"/>	C	Version with integrated heatsink	
	S	Version without heatsink	
1	-	Number of poles	
A	-	Switching mode: zero cross	
60	-	Rated voltage: 600 VAC (42-660 VAC) 50/60 Hz	
D	-	Control voltage: 4-32 VDC	
<input type="checkbox"/>	25	Rated current - 25 AAC	For RGC..only
	32	Rated current - 30 AAC, 37 AAC	For RGC..only
	42	Rated current - 43 AAC	For RGC..only
	62	Rated current - 65 AAC	For RGC..only
	50	Rated current - 50 AAC	For RGS..only
	92	Rated current - 90 AAC	For RGS..only
<input type="checkbox"/>	K	Screw connection for power terminals	
	G	Box clamp connection for power terminals	
E	-	Connection configuration	
N	-	For integration with NRG	

Selection guide - versions with integrated heatsink (RGC)

Rated voltage	Control voltage	Connection power	Rated operational current @ 40°C				
			25 AAC	30 AAC	37 AAC	43 AAC	65 AAC
			Product width				
600 VACrms	4 - 32 VDC	Screw	RGC1A60D25KEN	RGC1A60D32KEN	-	-	-
		Box clamp	-	-	RGC1A60D32GEN	RGC1A60D42GEN	RGC1A60D62GEN

Selection guide - versions without heatsink (RGS)

Rated voltage	Control voltage	Connection power	Maximum rated operational current				
			50 AAC	90 AAC	-	-	-
			Product width				
600 VACrms	4 - 32 VDC	Screw	RGS1A60D50KEN	RGS1A60D92KEN	-	-	-
		Box clamp	-	RGS1A60D92GEN	-	-	-

Further reading

Information	Where to find it	QR
User manual	http://www.productselection.net/MANUALS/UK/SSR_UM_NRG.pdf	
Online heatsink selector tool for RGS	http://www.productselection.net/heatsink/heatsinkSelector.php?LANG=UK	

RG..N



Structure

RGC..N

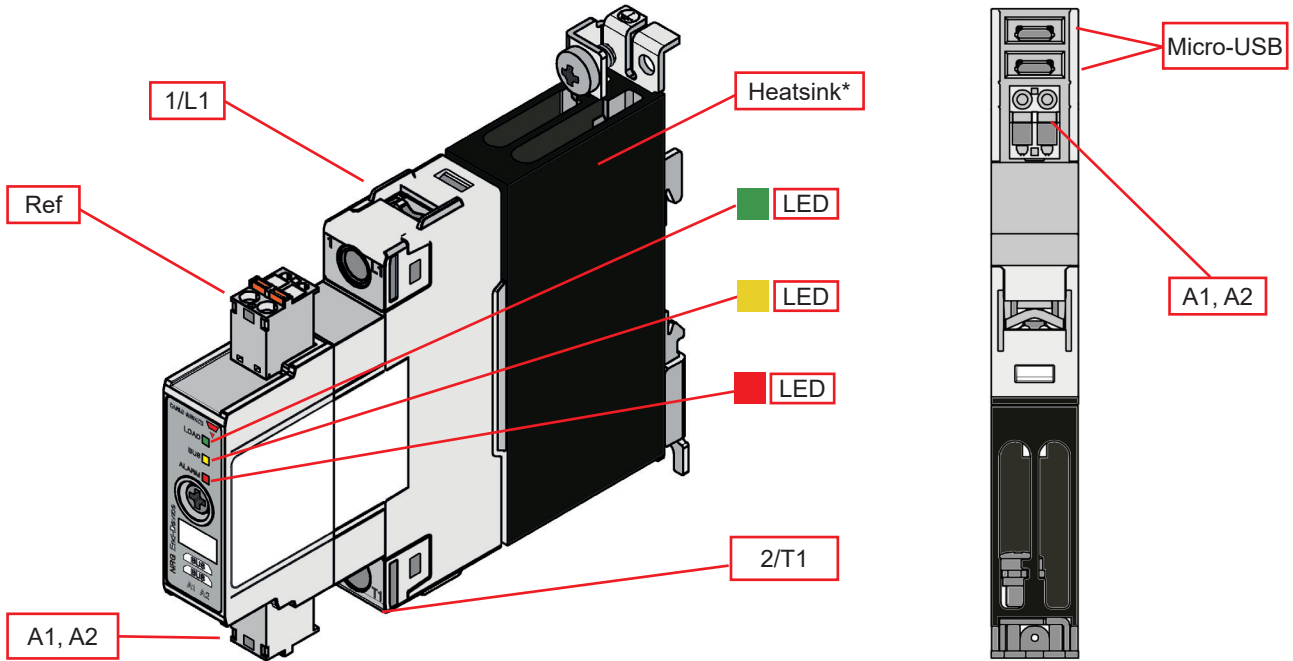

* integrated for RGC..N versions. RGS..N do not have an integrated heatsink

Element	Component	Function
1/L1	Power connection	Mains connection
2/T1	Power connection	Load connection
Ref	Voltage reference connection	Reference signal (L2 or N) for voltage measurement 2-pole plug internally shorted to allow for looping
A1, A2	Control connection	2-pole plug for control voltage
Green LED	LOAD indicator	Indicates status of RG..N output
Yellow LED	BUS indicator	Indicates ongoing communication
Red LED	ALARM indicator	Indicates presence of an alarm condition
Micro-USB	Micro-USB ports for internal BUS	Interface for RCRGN cable connection for the internal BUS communications line
Heatsink	Integrated heatsink	Integrated for RGC..N versions RGS..N versions do not have an integrated heatsink

Features

General data

Material	PA66 (UL94 V0), RAL7035 850°C, 750°C/2s according to GWIT and GWF1 requirements of EN 60335-1
Mounting	DIN rail (for RGC only) or panel
Touch Protection	IP20
Overvoltage Category	III, 6kV (1.2/50µs) rated impulse withstand voltage
Isolation	Input to Output: 2500 Vrms Input and Output to heatsink: 4000 Vrms
Weight	RGS..50: approx. 170 g RGS..92: approx. 170 g RGC..25: approx. 310 g RGC..32: approx. 310 g RGC..42: approx. 520 g RGC..62: approx. 1030 g
Compatibility	NRGC

Performance

RGS.. Output

	RGS..50..	RGS..92..
Operational voltage range, Ue	42 – 660 VAC	
Switching mode	Zero cross switching	
Max. operational current: AC-51 rating¹	50 AAC	90 AAC
Operational frequency range	50/60 Hz	
Blocking voltage	1200 Vp	
Power factor	> 0.9	
Output overvoltage protection	Integrated varistor across L1-T1	
Leakage current @ rated voltage	< 5 mAAC	
Minimum operational current	300 mAAC	500 mAAC
Maximum transient surge current (I_{TSM}), t=10 ms	600 Ap	1900 Ap
I²t for fusing (t=10ms), minimum	1,800 A ² s	18,000 A ² s
LED indication - LOAD	Green, ON when control output is ON	
Critical dV/dt (@Tj init = 40°C)	1000 V/µs	

1. Max. rated current with suitable heatsink. Refer to RGS heatsink selection tables.

▶ RGC.. Output

	RGC..25	RGC..32	RGC..42	RGC..62
Operational voltage range, Ue	42 - 660 VAC			
Switching mode	Zero cross switching			
Max. operational current: AC-51 rating @ 25°C ²	30 AAC	30 AAC KEN 43 AAC GEN	50 AAC	75 AAC
Max. operational current: AC-51 rating @ 40°C ²	25 AAC	30 AAC KEN 37 AAC GEN	43 AAC	65 AAC
Operational frequency range	50/60 Hz			
Blocking voltage	1200 Vp			
Power factor	> 0.9			
Output overvoltage protection	Integrated varistor across L1-T1			
Leakage current @ rated voltage	< 5 mAAC			
Minimum operational current	300 mAAC	500 mAAC	500 mAAC	500 mAAC
Maximum transient surge current (I _{TSM}), t=10 ms	600 Ap	1900 Ap	1900 Ap	1900 Ap
I ² t for fusing (t=10ms), minimum	1,800 A ² s	18,000 A ² s	18,000 A ² s	18,000 A ² s
LED indication - LOAD	Green, ON when output is ON			
Critical dV/dt (@Tj init = 40°C)	1000 V/μs			

2. Refer to RGC current derating curves for current ratings at different surrounding temperatures.

▶ Inputs

Control voltage range, U _c : A1, A2	4-32 VDC
Pick-up voltage	3.8 VDC
Drop-out voltage	1 VDC
Maximum reverse voltage	32 VDC
Maximum response time pick-up	½ cycle
Response time drop-out	½ cycle
Input current @ 40°C	See diagram below

Note: The output of the SSR is independent of the communications interface, therefore, the control voltage switches ON/OFF the output of the SSR even when this is not connected to the BUS chain (i.e., the RCRGN cable is not connected or a problematic BUS communication line).

▶ Input current vs. input voltage

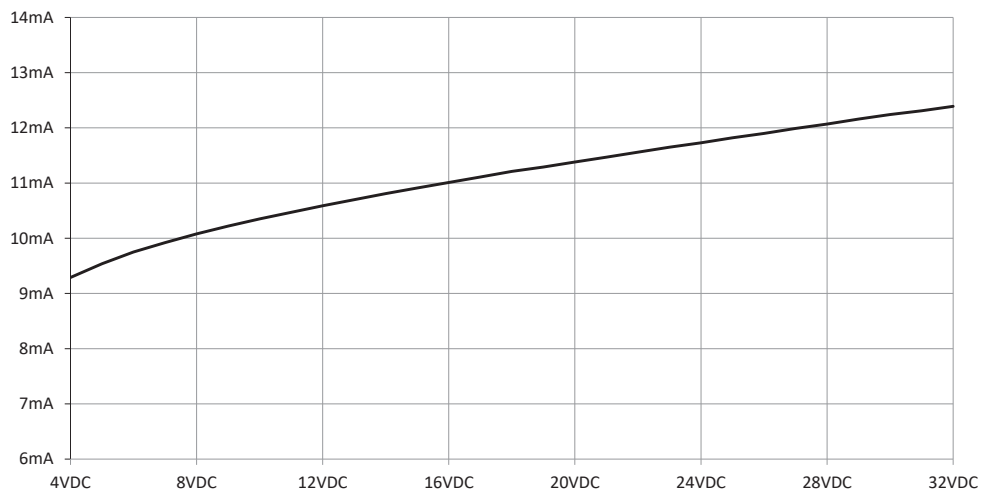

Internal bus

Supply voltage	Supplied through 2 wires of the RCRGN bus cable when connected to a powered NRGC
BUS termination	RGN-TERMRES on last device in the bus chain
Max. no. of RG..Ns in a bus chain	48
LED indication - BUS	Yellow, ON during ongoing communication
ID for RG..Ns	Automatic through AutoConfiguration (refer to NRG User Manual for further details) Communication is only possible with RG..Ns that are configured correctly, i.e., they have a valid ID.

Output power dissipation

RGS..

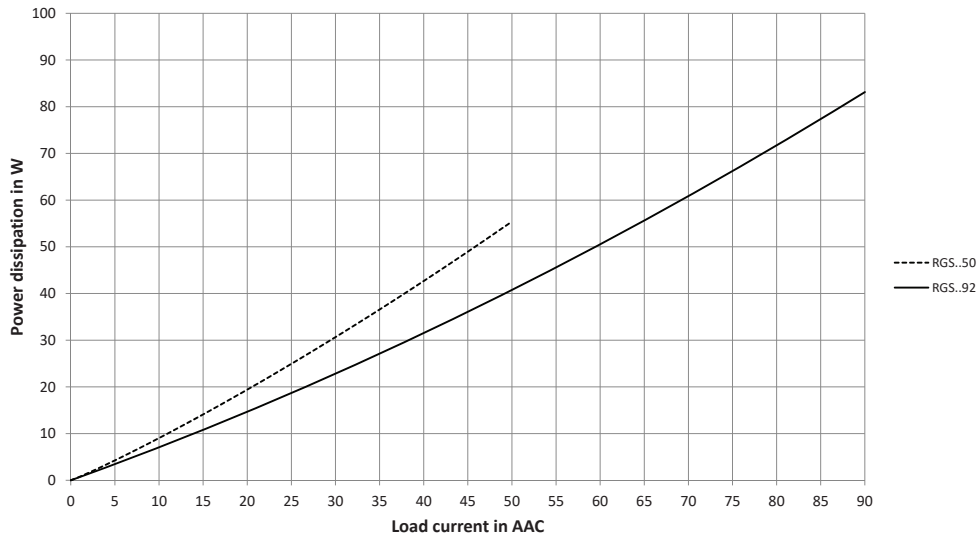

RGC..

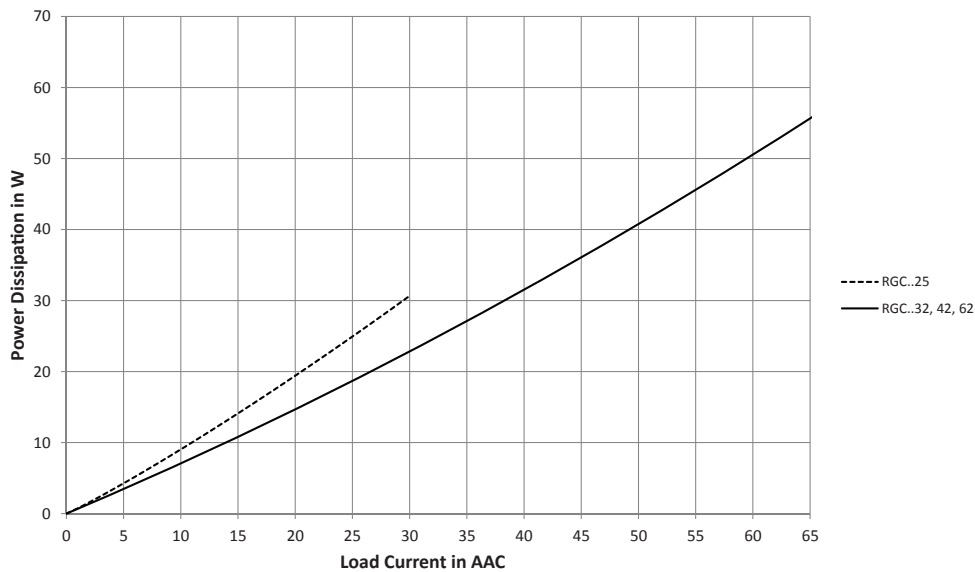

▶ RGS.. Heatsink selection

Thermal resistance [°C/W] of RGS..50

Load current per pole AC-51 [A]	Surrounding ambient temperature [°C]					
	20	30	40	50	60	65
50	1.45	1.28	1.06	0.87	0.68	0.59
45	1.72	1.50	1.29	1.07	0.85	0.75
40	2.00	1.75	1.50	1.25	1.00	0.87
35	2.35	2.06	1.76	1.47	1.18	1.03
30	2.83	2.48	2.13	1.77	1.42	1.24
25	3.52	3.08	2.64	2.20	1.76	1.54
20	4.58	4.01	3.44	2.86	2.29	2.01
15	6.40	5.60	4.80	4.00	3.20	2.80
10	10.19	8.92	7.64	6.37	5.10	4.46
5	--	19.51	16.72	13.94	11.15	9.76

Thermal resistance [°C/W] of RGS..92

Load current per pole AC-51 [A]	Surrounding ambient temperature [°C]					
	20	30	40	50	60	65
90	0.62	0.52	0.41	0.31	0.21	0.16
81	0.77	0.66	0.54	0.42	0.31	0.25
72	0.97	0.83	0.70	0.56	0.43	0.36
63	1.23	1.07	0.91	0.75	0.59	0.51
54	1.55	1.35	1.16	0.97	0.77	0.68
45	1.93	1.69	1.45	1.21	0.97	0.85
36	2.53	2.21	1.89	1.58	1.26	1.11
27	3.55	3.11	2.66	2.22	1.77	1.55
18	5.67	4.97	4.26	3.55	2.84	2.48
9	12.46	10.90	9.34	7.79	6.23	5.45

▶ RGS.. Thermal data

	RGS..50	RGS..92
Max. junction temperature	125°C	
Heatsink temperature	100°C	
Junction to case thermal resistance, R_{thjc}	< 0.30 °C/W	< 0.20 °C/W
Case to heatsink thermal resistance, R_{thcs}	< 0.25 °C/W	

▶ RGC.. Current derating

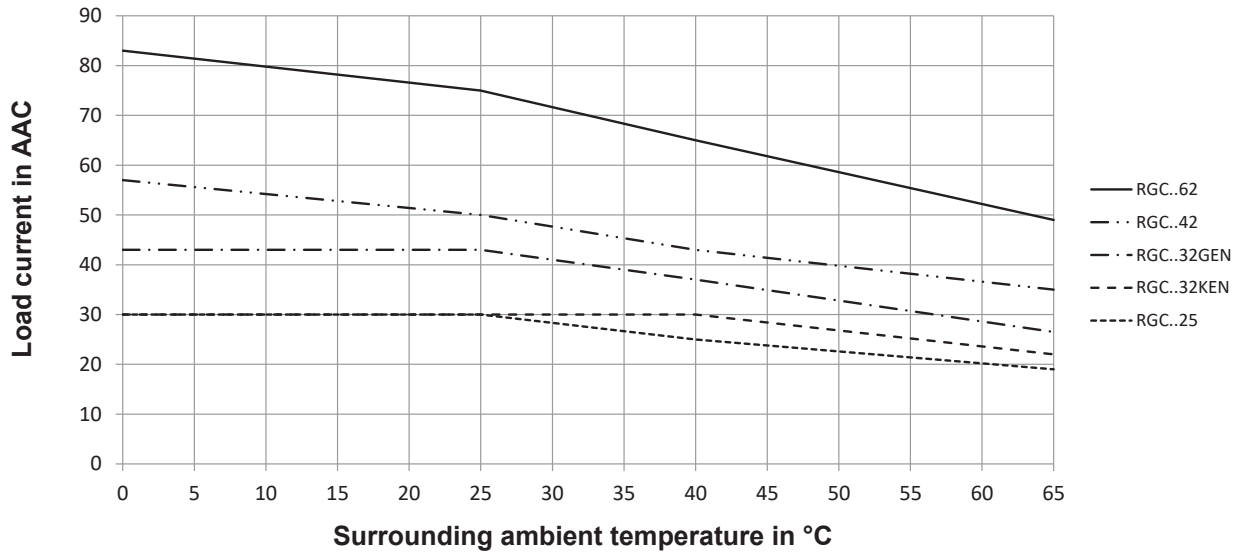

▶ RGC.. Derating vs spacing

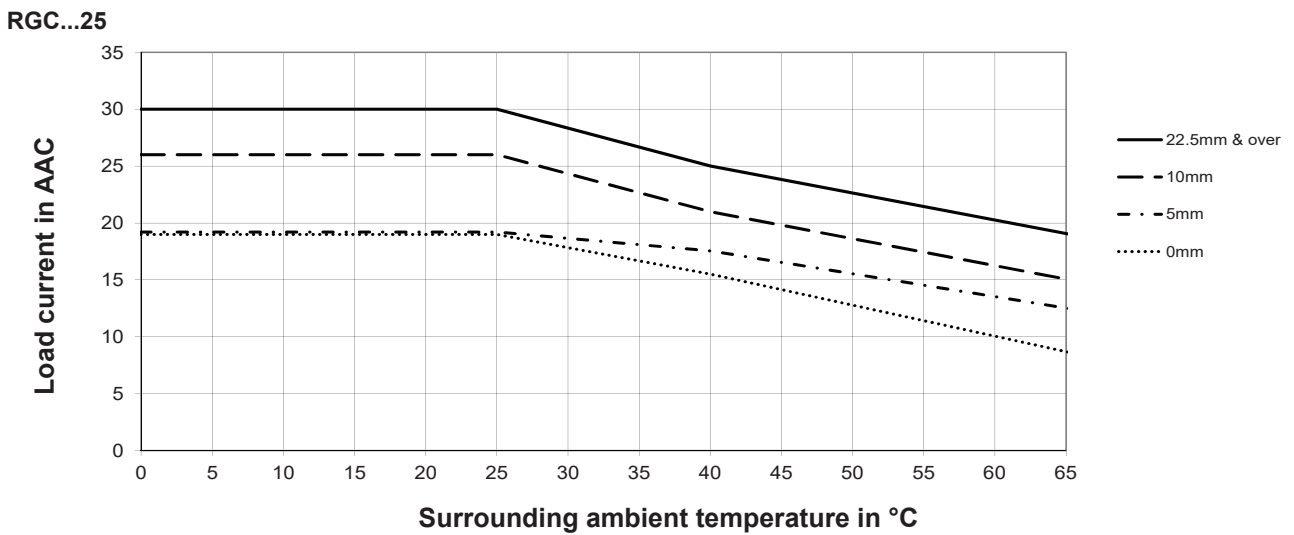

RGC...32

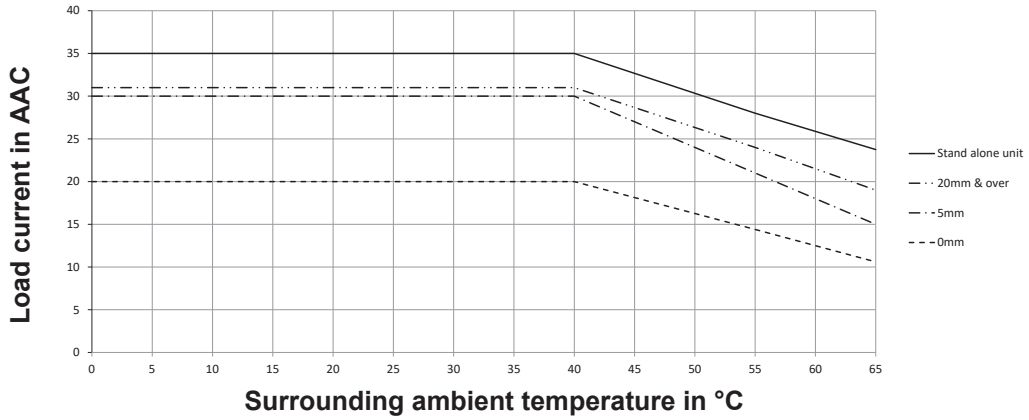



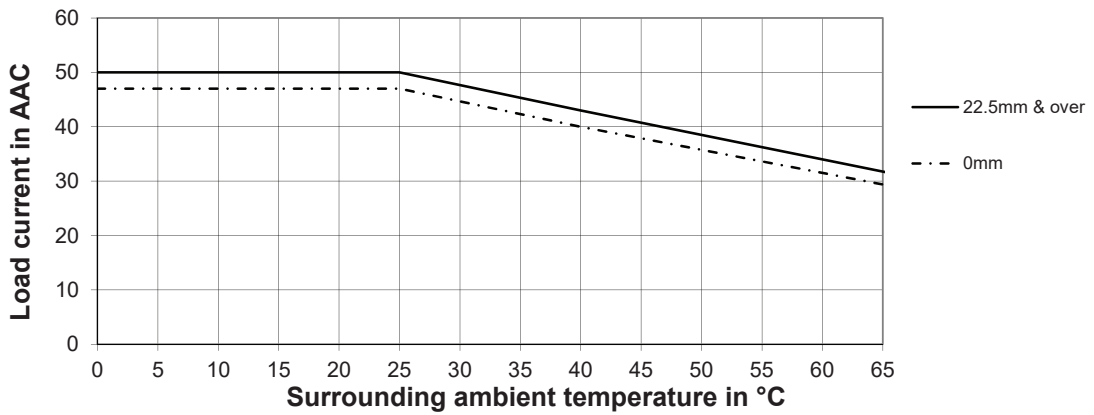

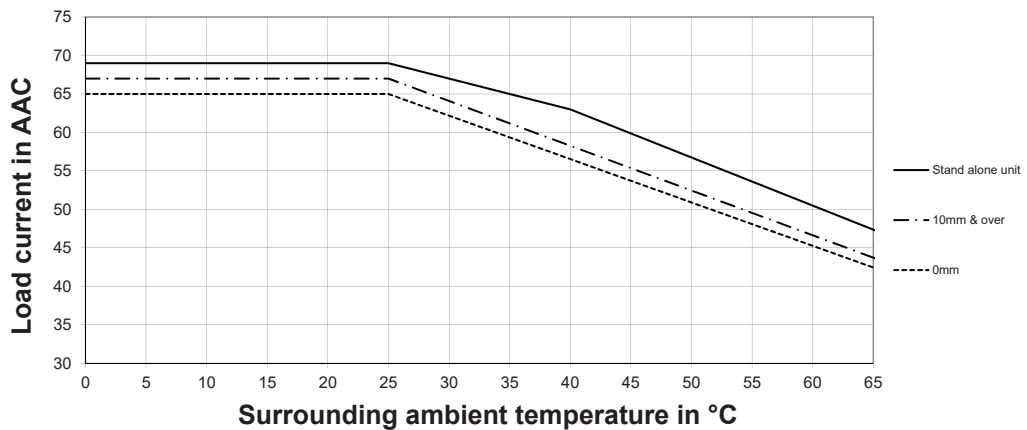

RGC...42



RGC...62



Compatibility and conformance

Approvals	RGC:   
	RGS:    
Standards compliance	LVD: EN 60947-4-3 EMCD: EN 60947-4-3 UL: UL508, E172877, NMFT cUL: C22.2 No. 14-13, E172877, NMFT7 UR: UL508, E172877, NMFT2 cUR: C22.2 No. 14-13, E172877, NMFT8 CSA: C22.2 No. 14-13, 204075
UL short circuit current rating	100k Arms (refer to short circuit current section, Type 1 – UL508)

Electromagnetic compatibility (EMC) - Immunity

Electrostatic discharge (ESD)	EN/IEC 61000-4-2 8 kV air discharge, 4 kV contact (PC1)
Radiated radio frequency ³	EN/IEC 61000-4-3 10 V/m, from 80 MHz to 1 GHz (PC1) 10 V/m, from 1.4 to 2 GHz (PC1) 3 V/m, from 2 to 2.7 GHz (PC1)
Electrical fast transient (burst)	EN/IEC 61000-4-4 Output: 2 kV, 5 kHz & 100 kHz (PC1) Input: 1 kV, 5 kHz & 100 kHz (PC1)
Conducted radio frequency ³	EN/IEC 61000-4-6 10V/m, from 0.15 to 80 MHz (PC1)
Electrical surge	EN/IEC 61000-4-5 Output, line to line: 1 kV (PC2) Output, line to earth: 2 kV (PC2) Input, line to line: 500 V (PC2) Input, line to earth: 500 V (PC2) Signal, line to earth: 1 kV (PC2) ⁴
Voltage dips	EN/IEC 61000-4-11 0% for 0.5, 1 cycle (PC2) 40% for 10 cycles (PC2) 70% for 25 cycles (PC2) 80% for 250 cycles (PC2)
Voltage interruptions	EN/IEC 61000-4-11 0% for 5000ms (PC2)

3. Under the influence of RF, a reading error of $\pm 10\%$ was allowed for load currents $> 500\text{mA}$ and $\pm 20\%$ for load currents $< 500\text{mA}$. These tolerances are not maintained if Ref signal is not connected.

4. Not applicable to shielded cables $< 10\text{m}$. Additional suppression on data lines may be required if shielded cables are not used.

Electromagnetic compatibility (EMC) - Emissions

Radio interference field emission (radiated)	EN/IEC 55011 Class A: from 30 to 1000 MHz
Radio interference voltage emissions (conducted)	EN/IEC 55011 Class A: from 0.15 to 30 MHz (External filter may be required - refer to Filtering section)

Filter connection diagram

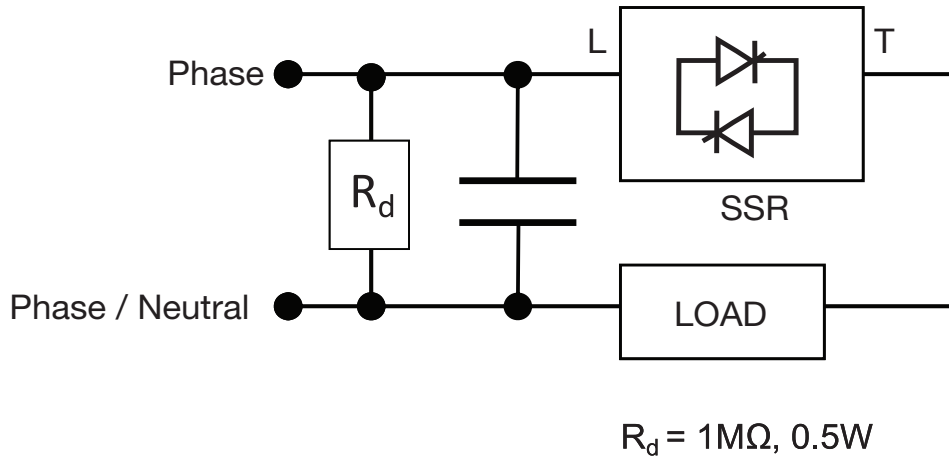

Filtering

Part number	Suggested filter for EN 55011 Class A compliance	Maximum heater current [AAC]
RGS..50..	330 nF / 760 V / X1	30 A
RGS..92..	220 nF / 760 V / X1	30 A
RGC..25..	220 nF / 760 V / X1	30 A
RGC..32..	330 nF / 760 V / X1	40 A
RGC..42.. , RGC..62..	330 nF / 760 V / X1 680 nF / 760 V / X1	40 A 65 A

Note:

- Control input lines must be installed together to maintain products' susceptibility to Radio Frequency interference.
- Use of AC solid state relays may, according to the application and the load current, cause conducted radio interferences. Use of mains filters may be necessary for cases where the user must meet E.M.C requirements. The capacitor values given inside the filtering specification tables should be taken only as indications, the filter attenuation will depend on the final application.
- Performance Criteria 1 (PC1) : No degradation of performance or loss of function is allowed when the product is operated as intended.
- Performance Criteria 2 (PC2): During the test, degradation of performance or partial loss of function is allowed. However when the test is complete the product should return operating as intended by itself.
- Performance Criteria 3 (PC3): Temporary loss of function is allowed, provided the function can be restored by manual operation of the controls.

Environmental specifications

Operating temperature	-20 to +65 °C (-4 to +149 °F)
Storage temperature	-20 to +65 °C (-4 to +149 °F)
Relative humidity	95% non-condensing @ 40°C
Pollution degree	2
Installation altitude	0-1000m Above 1000m derate linearly by 1% of FLC per 100m up to a maximum of 2000m
Vibration resistance	2g/ axis (2-100Hz, IEC60068-2-6, EN 50155)
Impact resistance	15/11 g/ms (EN 50155)
EU RoHS compliant	Yes
China RoHS	

The declaration in this section is prepared in compliance with People's Republic of China Electronic Industry Standard SJ/T11364-2014: Marking for the Restricted Use of Hazardous Substances in Electronic and Electrical Products.

Part Name	Toxic or Harardous Substances and Elements					
	Lead (Pb)	Mercury (Hg)	Cadmium (Cd)	Hexavalent Chromium (Cr(VI))	Polybrominated biphenyls (PBB)	Polybrominated diphenyl ethers (PBDE)
Power Unit Assembly	x	o	o	o	o	o

O: Indicates that said hazardous substance contained in homogeneous materials for this part are below the limit requirement of GB/T 26572.

X: Indicates that said hazardous substance contained in one of the homogeneous materials used for this part is above the limit requirement of GB/T 26572.

这份申明根据中华人民共和国电子工业标准 SJ/T11364-2014：标注在电子电气产品中限定使用的有害物质

零件名称	有毒或有害物质与元素					
	铅 (Pb)	汞 (Hg)	镉 (Cd)	六价铬 (Cr(VI))	多溴化联苯 (PBB)	多溴联苯醚 (PBDE)
功率单元	x	o	o	o	o	o

O:此零件所有材料中含有的该有害物低于GB/T 26572的限定。

X: 此零件某种材料中含有的该有害物高于GB/T 26572的限定。



Measurements

Parameter	Register reference	Description
Current	CRRDR	This reports the measured load RMS current.
Hold current	CUHDR	This reports the highest RMS value of current recorded over a number of (past) cycles. The number of past cycles is configurable.
Voltage	VRRDR	RMS voltage reading (L1-Ref voltage) that is the supply voltage across the SSR + load (Ref signal connection is required)
Frequency	FQRDR	This reports the measured line frequency.
Apparent power	APRDR	This reports the apparent power that is a multiplication of the voltage RMS value and current RMS value. (Ref signal connection is required)
Real power	RPRDR	This reports the real power reading that is based on the instantaneous voltage & current multiplications. (Ref signal connection is required)
Running hours (On-time)	OTRDR	This is a count of the time during which the SSR output is ON. On switch ON, this register reports the recorded value at the last switch OFF.
Active Energy	ENRDLR, ENRDHR	This reports the energy reading in kWh. On switch ON, this register reports the recorded value at the last switch OFF. (Ref signal connection is required)

Note 1: For further information please refer to the 'NRG user manual'.

Note 2: Ref signal connection is recommended with loads less than 1A

LED indicators

LOAD	Green 	The Load LED reflects the status of the load depending on the presence of the control signal. During an over-temperature condition, the LOAD LED will behave according to the indications in the table "LOAD LED indications in over-temperature condition" below	
BUS	Yellow 	ON:	During a response from the RG..N to the NRGC
		OFF:	Communication between the NRGC and RG..Ns is idle or during the transmission of a command from the NRGC to the RG..N
ALARM	Red 	ON:	Fully ON or flashing when alarm condition is present. Refer to Alarm Management section
		OFF:	No alarm condition

LOAD LED indications in over-temperature condition

Control signal A1, A2	RG..N supply (through internal bus by RCRGN..)	Over-temperature condition	LOAD LED green 
ON	OFF	Detection not possible without BUS connected	ON
ON	ON	OFF	ON
ON	ON	ON	OFF
OFF	OFF	Detection not possible without BUS connected	OFF
OFF	ON	ON	OFF
OFF	ON	OFF	OFF

Alarm management

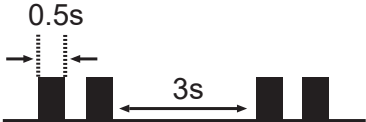
Alarm condition present	<ul style="list-style-type: none"> The state of the Red LED of the respective RG..N is ON with a specific flashing rate Alarm flag (AL1SF), Comms error flag (CMERF) or internal error flag (INERF) in the RG..N status register (EDGSR) is set Any of the flags in the Alarm 1 status register (AL1SR) of the respective RG..N is set <p>Please refer to the NRG User Manual for further information</p>	
Alarm types	No. of flashes	Description of fault
	100% ON	Over-temperature: - The RG..N is operating outside its operating range causing the junction to overheat - The output of the RG..N is switched OFF (irrespective of the control voltage presence) to prevent damage to the RG..N - The alarm is restored automatically after the cooling-off period
	2	System 1 fault: Voltage and current signals are absent. This could be due to a mains loss or a load loss under specific conditions. Refer to the NRG User Manual for further details.
	3	System 2 fault: Load loss or SSR open circuit
	4	SSR short circuit: Current flowing through the RG..N output in the absence of a control signal
	5	Frequency Out of Range: - The RG..N is operated outside the range set by the Over Frequency and Under Frequency Limit registers (OFLMR and UFLMR). - Default range is 44 – 66 Hz - The RG..N will not stop operating if the frequency measured is out of the set range. The alarm is restored automatically when the frequency is back within the expected range
	6	Current Out of Range: - The RG..N is operated outside the range set by the Over Current and Under Current Limit registers (OCLMR and UCLMR). - Default range is 0 – max. rating of the respective RG..N - The RG..N will not stop operating if the current measured is out of the set range. The alarm is restored automatically when the current is back within the expected range
	7	Voltage Out of Range: - The RG..N is operated outside the range set by the Over Voltage and Under Voltage Limit registers (OVLMR and UVLMR). - Default range is 0 – 660 V - The RG..N will not stop operating if the voltage measured is out of the set range. The alarm is restored automatically when the voltage is back within the expected range
	8	Communication error (BUS): An error in the communication link (internal bus) between the NRG and RG..Ns
	9	Internal error: Bus supply out of range, hardware damage or detection of abnormal conditions
Flashing rate		

Short circuit protection

Protection Co-ordination, Type 1 vs Type 2:

Type 1 protection implies that after a short circuit, the device under test will no longer be in a functioning state. In Type 2 co-ordination the device under test will still be functional after the short circuit. In both cases, however the short circuit has to be interrupted. The fuse between enclosure and supply shall not open. The door or cover of the enclosure shall not be blown open. There shall be no damage to conductors or terminals and the conductors shall not separate from terminals. there shall be no breakage or cracking of insulating bases to the extent that the integrity of the mounting of live parts is impaired. Discharge of parts or any risk of fire shall not occur.

The product variants listed in the table hereunder are suitable for use on a circuit capable of delivering not more than 100,000A rms Symmetrical Amperes, 600 Volts maximum when protected by fuses. Tests at 100,000A were performed with Class J fuses, fast acting; please refer to the table below for maximum allowed ampere rating of the fuse. Use fuses only.

Tests with Class J fuses are representative of Class CC fuses.

Protection co-ordination Type 1 according to UL 508				
Part No.	Prospective short circuit current [kArms]	Max fuse size [A]	Class	Voltage [VAC]
RGS..50, RGC..25	100	30	J or CC	max. 600
RGS..92, RGC..32, RGC..42, RGC..62	100	80	J	max. 600

Protection co-ordination Type 2 with semiconductor fuses						
Part number	Prospective short circuit current [kArms]	Mersen (Ferraz Shawmut)		Siba		Voltage [VAC]
		Max fuse size [A]	Part number	Max fuse size [A]	Part number	
RGC..25	10	40	6.9xx CP GRC 22x58 /40	32	50 142 06.32	max. 600
	100	40	6.9xx CP GRC 22x58 /40	32	50 142 06.32	max. 600
RGC..32 RGC..42	10	63	6.9xx CP URC 14x51 /63	80	50 194 20.80	max. 600
	10	70	A70QS70-4	80	50 194 20.80	max. 600
	100	63	6.9xx CP URC 14x51 /63	80	50 194 20.80	max. 600
	100	70	A70QS70-4	80	50 194 20.80	max. 600
RGC..62	10	100	6.9xx CP GRC 22x58 /100	100	50 194 20.100	max. 600
	10	100	A70QS100-4	100	50 194 20.100	max. 600
	100	100	6.621 CP URGD 27x60 /100	100	50 194 20.100	max. 600
	100	100	A70QS100-4	100	50 194 20.100	max. 600
RGS..50	10	80	6.621 CP URQ 27x60 /80	50	50 142 06.50	max. 660
	10	70	A70QS70-4	50	50 142 06.50	max. 660
	100	80	6.621 CP URQ 27x60 /80	50	50 142 06.50	max. 660
	100	70	A70QS70-4	50	50 142 06.50	max. 660
RGS..92	10	125	6.621 CP URD 22x58 /125	125	50 194 20.125	max. 660
	10	125	A70QS125-4	125	50 194 20.125	max. 660
	100	125	6.621 CP URD 22x58 /125	125	50 194 20.125	max. 660
	100	125	A70QS125-4	125	50 194 20.125	max. 660

Protection co-ordination Type 2 with Miniature Circuit Breakers (M.C.B.s)				
Solid State Relay type	ABB Model no. for Z - type M. C. B. (rated current)	ABB Model no. for B - type M. C. B. (rated current)	Wire cross sectional area [mm ²]	Minimum length of Cu wire conductor [m] ⁵
RGS..50, RGC..25 (1800 A ² s)	1-pole S201 - Z10 (10A)	S201-B4 (4A)	1.0	7.6
			1.5	11.4
			2.5	19.0
	S201 - Z16 (16A)	S201-B6 (6A)	1.0	5.2
			1.5	7.8
			2.5	13.0
			4.0	20.8
	S201 - Z20 (20A)	S201-B10 (10A)	1.5	12.6
			2.5	21.0
	S201 - Z25 (25A)	S201-B13 (13A)	2.5	25.0
4.0			40.0	
2-pole S202 - Z25 (25A)	S202-B13 (13A)	2.5	19.0	
		4.0	30.4	
RGS..92, RGC..32, RGC..42, RGC..62 (18000 A ² s)	1-pole S201 - Z32 (32A)	S201-B16 (16A)	2.5	3.0
			4.0	4.8
			6.0	7.2
	S201 - Z50 (50A)	S201-B25 (25A)	4.0	4.8
			6.0	7.2
			10.0	12.0
			16.0	19.2
	S201 - Z63 (63A)	S201-B32 (32A)	6.0	7.2
			10.0	12.0
			16.0	19.2

5. Between MCB and Load (including return path which goes back to the mains)

Note: A prospective current of 6kA and a 230 / 400 V power supply is assumed for the above suggested specifications. For cables with different cross section than those mentioned above please consult Carlo Gavazzi's Technical Support Group.

Dimensions

RGS...KEN

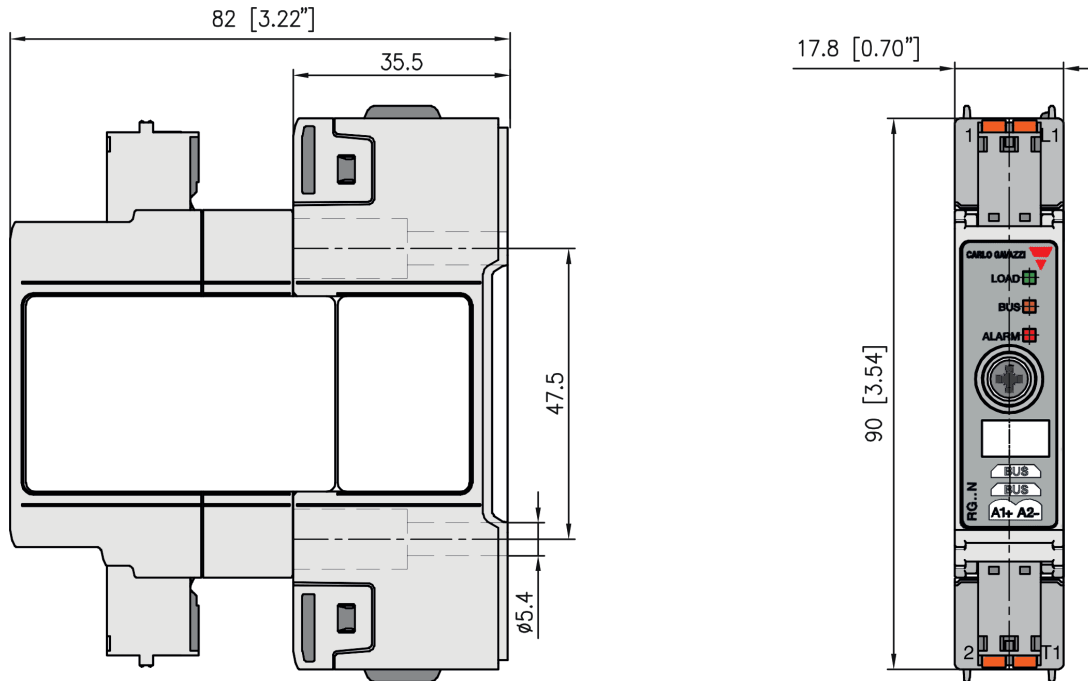

RGS...GEN

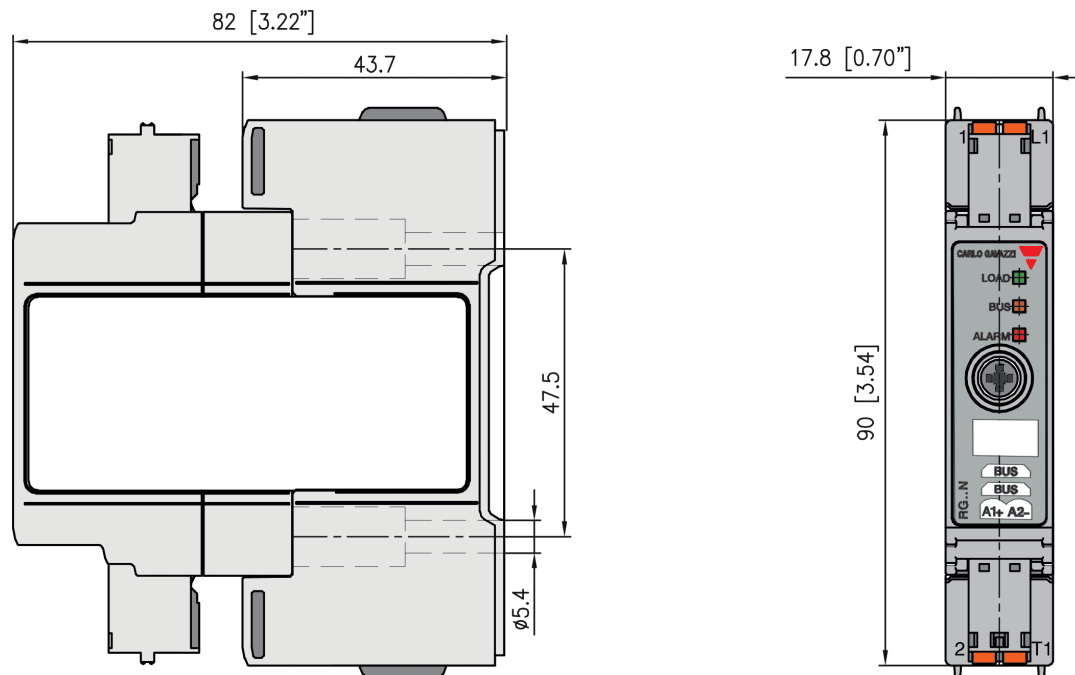

Housing width tolerance +0.5mm, -0mm as per DIN 43880.
 All other tolerances +/- 0.5mm.
 Dimensions in mm.

RGC...25KEN, RGC...32KEN

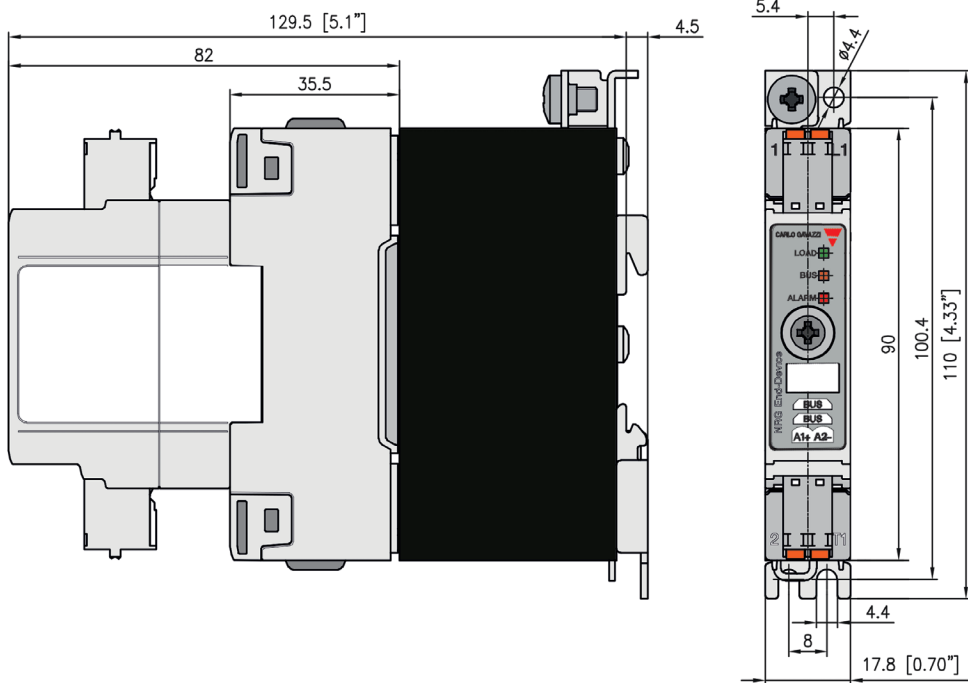

RGC...32GEN

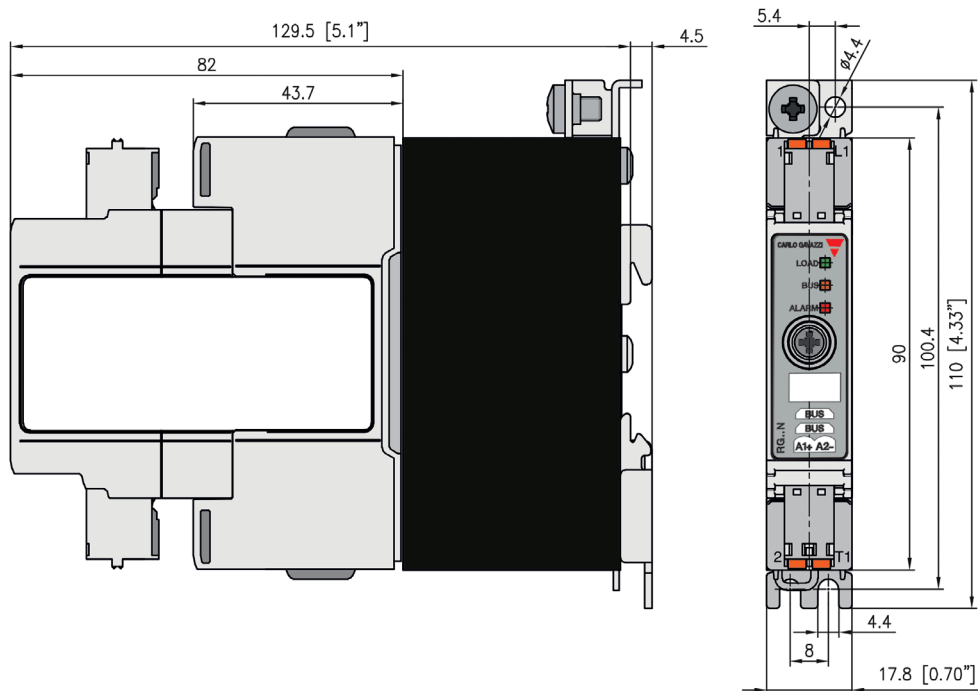

Housing width tolerance +0.5mm, -0mm as per DIN 43880.
 All other tolerances +/- 0.5mm.
 Dimensions in mm.

RGC...42GEN

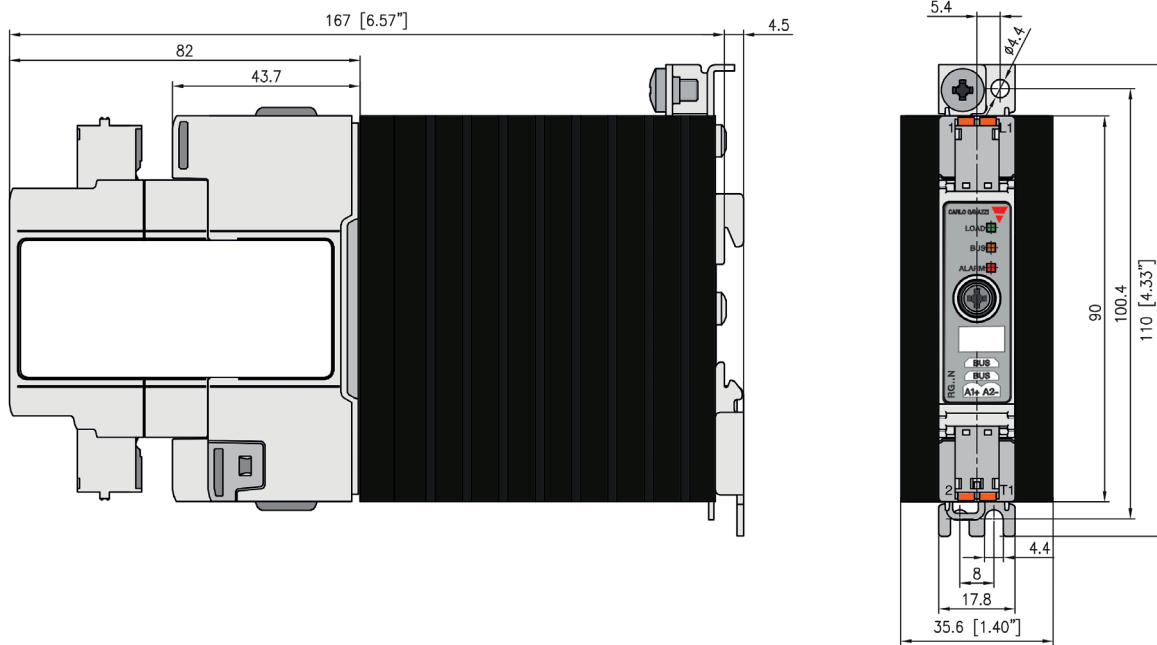

RGC...62GEN

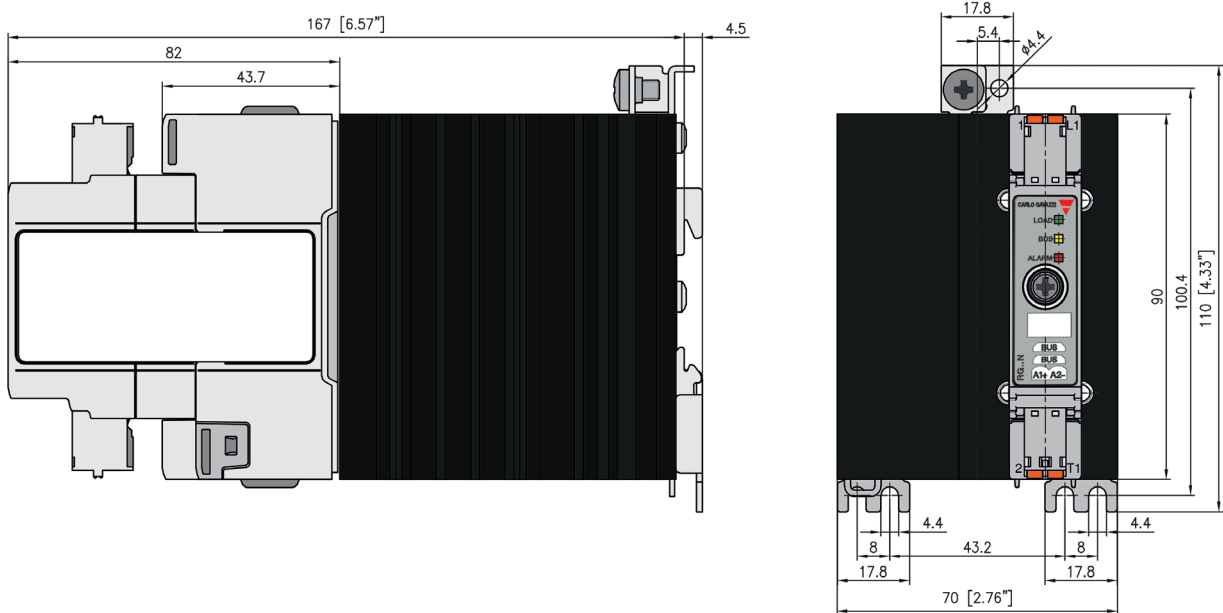

Housing width tolerance +0.5mm, -0mm as per DIN 43880.
 All other tolerances +/- 0.5mm.
 Dimensions in mm.

▶ Load connection diagram

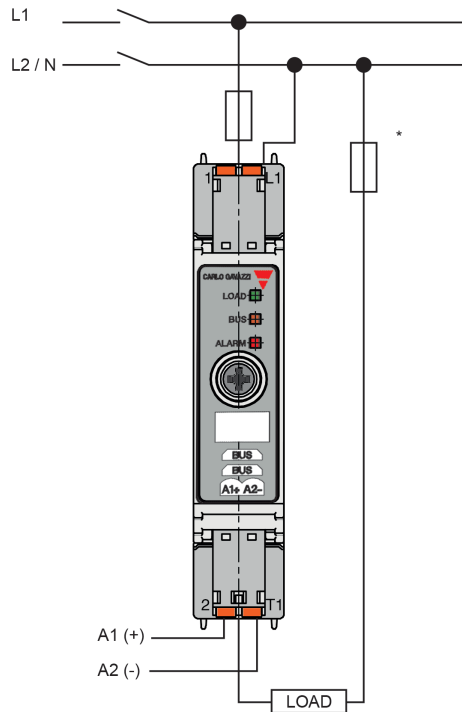

*depends on system requirements

BUS connection diagram

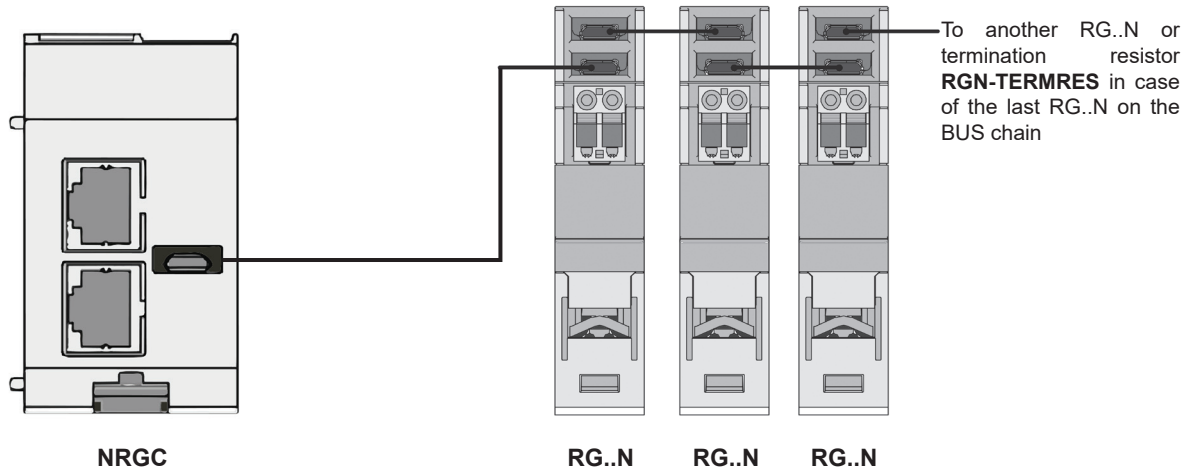

Functional diagram

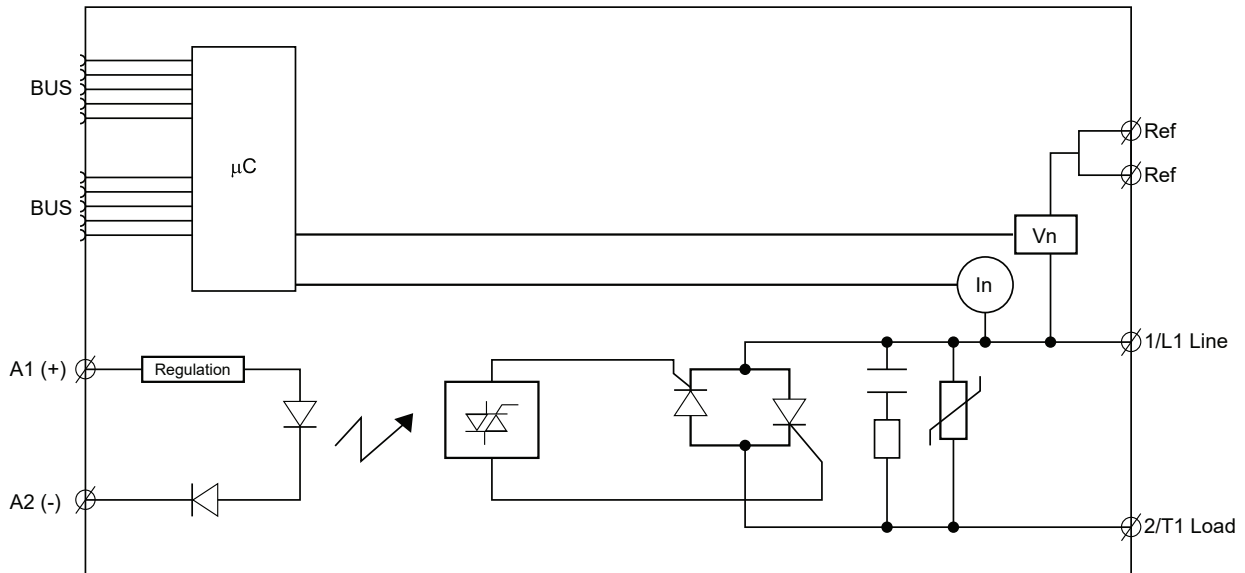

Mounting

RGC

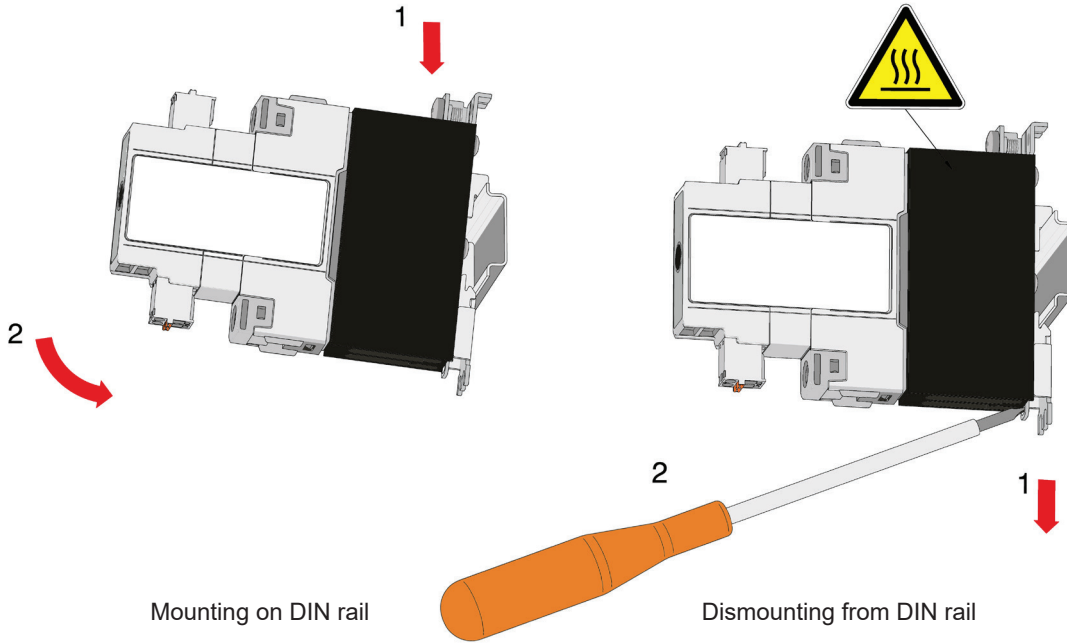

RGS

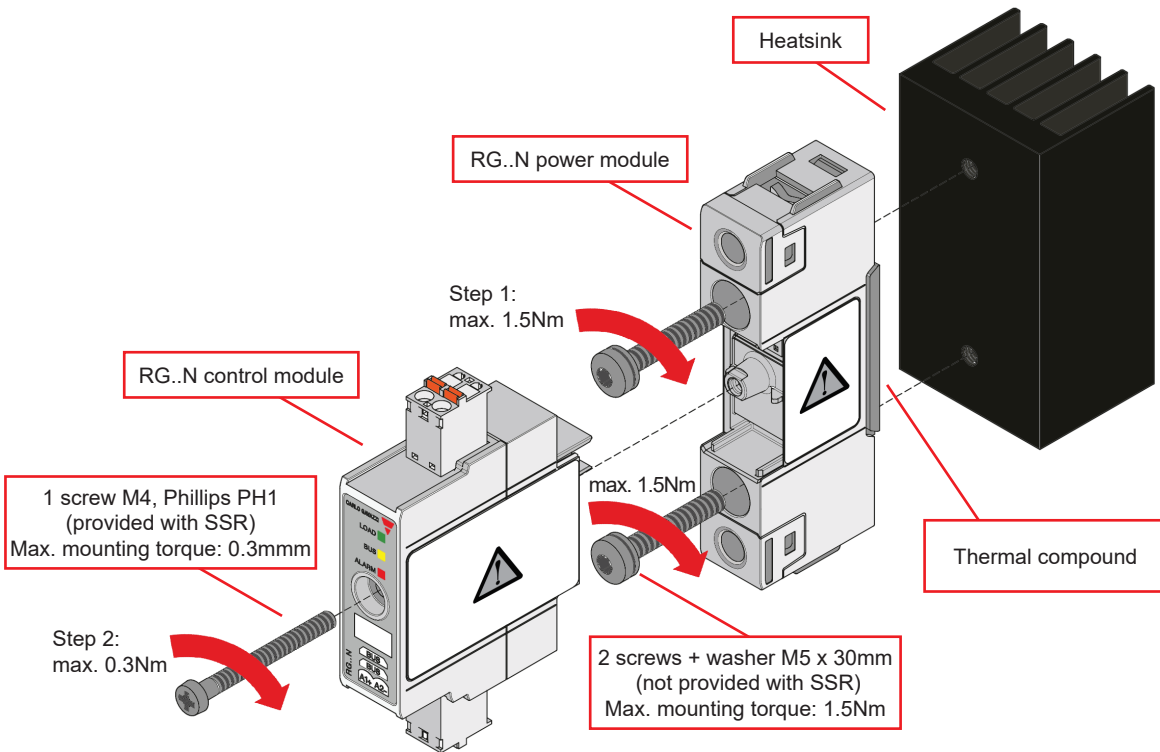

- Step 1: Mount RG..N power module to Heatsink
- Step 2: Mount RG..N control module on RG..N power module

Make sure that the date code (Mxxxxxxxxxxxx) marked on the side labelling of the 2 modules (i.e., the power module and control module) matches before mounting

Installation

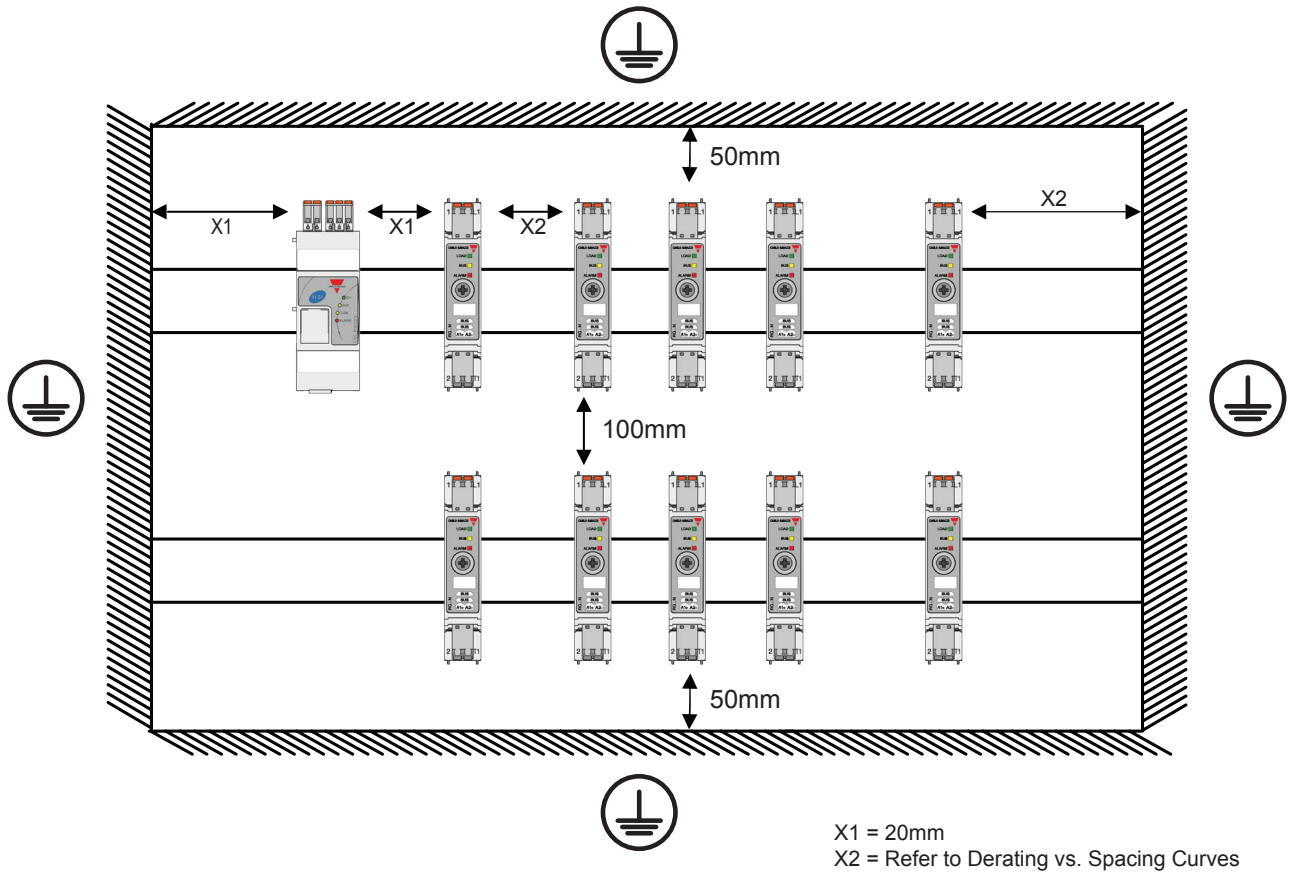

Connection specifications

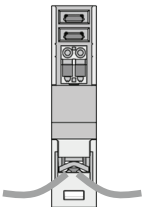
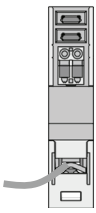
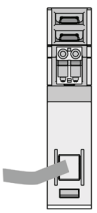
Power connection			
Terminal	1/L1, 2/T1		
Conductors	Use 75°C copper (Cu) conductors		
	RG..KEN		RG..GEN
			
Stripping length	12mm		11mm
Connection type	M4 screw with captivated washer		M5 screw with box clamp
Rigid (solid & stranded) UL/CSA rated data	2x 2.5 – 6.0mm ² 2x 14 – 10 AWG	1x 2.5 – 6.0mm ² 1x 14 – 10 AWG	1x 2.5 – 25.0mm ² 1x 14 – 3 AWG
Flexible with end sleeve	2x 1.0 – 2.5mm ² 2x 2.5 – 4.0mm ² 2x 18 – 14 AWG 2x 14 – 12 AWG	1x 1.0 – 4.0mm ² 1x 18 – 12 AWG	1x 2.5 – 16.0mm ² 1x 14 – 6 AWG
Flexible without end sleeve	2x 1.0 – 2.5mm ² 2x 2.5 – 6.0mm ² 2x 18 – 14 AWG 2x 14 – 10 AWG	1x 1.0 – 6.0mm ² 1x 18 – 10 AWG	1x 4.0 – 25.0mm ² 1x 12 – 3 AWG
Torque specifications	Posidrive bit 2 UL: 2.0 Nm (17.7 lb-in) IEC: 1.5 – 2.0 Nm (13.3 – 17.7 lb-in)		Posidrive bit 2 UL: 2.5Nm (22 lb-in) IEC: 2.5 – 3.0 Nm (22 – 26.6 lb-in)
Aperture for termination lug (fork or ring)	12.3 mm		n/a
Protective Earth (PE) connection	M5, 1.5Nm (13.3 lb-in) M5 PE screw is not provided with the solid state relay. PE connection is required when product is intended to be used in Class 1 applications according to EN/IEC 61140		

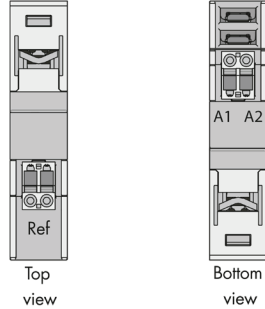
Control & Ref connection	
Terminals	Ref (x2 poles internally shorted on RG..N) A1+, A2-
	 <p>Top view</p> <p>Bottom view</p>
Conductors	Use 60/75°C copper (Cu) conductors
Stripping length	11 – 12mm
Connection type	Spring plug, pitch 5.08mm
Rigid (solid & stranded) UL/CSA rated data	0.2 – 2.5mm ² , 26 – 12 AWG
Flexible with end sleeve	0.25 – 2.5mm ²
Flexible without end sleeve	0.25 – 2.5mm ²
Flexible with end sleeve using TWIN ferrules	0.5 – 1.0mm ²
Ref internal short current handling capability	< 2 AAC

BUS connection	
Terminal	BUS (x2)
	 <p>BUS</p> <p>BUS</p> <p>Bottom view</p>
Type	RCRGN-xxx (where xxx refers to the length in cm) 5-way terminated with micro USB connector Cable lengths available: 10cm RCRGN-010-2 75cm RCRGN-075-2 150cm RCRGN-150-2 350cm RCRGN-350-2 500cm RCRGN-500-2
Conductors	+24V, GND, Data, Data, Autoconfig line

NRG controller with Modbus RTU over RS485



Main features

- Communication interface: Modbus over RS485
- Connects up to 48 RG..N solid state relays
- Supply voltage: 24 VDC +/- 20%
- 1 configurable electromechanical relay output (default set as Alarm output)
- Product width: 35mm
- Selector switch for Modbus addresses 1-15 *
- LED indication for ON, COM, BUS and ALARM status

* (Modbus addresses 1 - 247 through comms)

Description

The **NRGC** is the controller of the NRG BUS chains and interfaces directly with the main controller of the system through Modbus RTU on an RS485 interface. Each NRGC in the system is identified by a unique Modbus address that can be set either manually via a front selector switch that allows only Modbus addresses 1 to 15 or through dedicated registers for addresses 1 to 247. The default Modbus communication settings can also be modified via dedicated registers.

The NRGC acts as a master of the respective BUS chain when it is requested by the main controller to carry out actions on the specific BUS chain. Otherwise, the NRGC is just a facilitator of the communication between the main controller and each individual RG..N solid state relay in the system.

The NRGC needs to be supplied with 24 VDC. It is equipped with a digital output consisting of an electromechanical relay that is set as an NRGC alarm relay as the default setting. This can be modified and set as an auxiliary digital output to be controlled by the main controller of the system.

LEDs on the front facade give a visual indication of the status of the NRGC, of any ongoing communication with the main controller (COM) and the RG..Ns on the BUS chain (BUS) and of any alarm condition of the NRGC.

Specifications are noted at 25°C unless otherwise specified.

Order code

NRGC

Carlo Gavazzi compatible components

Description	Component code	Notes
Relays	RG..N	NRG solid state relays
NRG Internal BUS cables	RCRGN-010-2	10cm cable terminated at both ends with a microUSB connector. Packed x4 pcs.
	RCRGN-075-2	75cm cable terminated at both ends with a microUSB connector. Packed x1 pc.
	RCRGN-150-2	150cm cable terminated at both ends with a microUSB connector. Packed x1 pc.
	RCRGN-350-2	350cm cable terminated at both ends with a microUSB connector. Packed x1 pc.
	RCRGN-500-2	500cm cable terminated at both ends with a microUSB connector. Packed x1 pc.

Further reading

Information	Where to find it	QR
User manual	http://www.productselection.net/MANUALS/UK/SSR_UM_NRG.pdf	

Structure

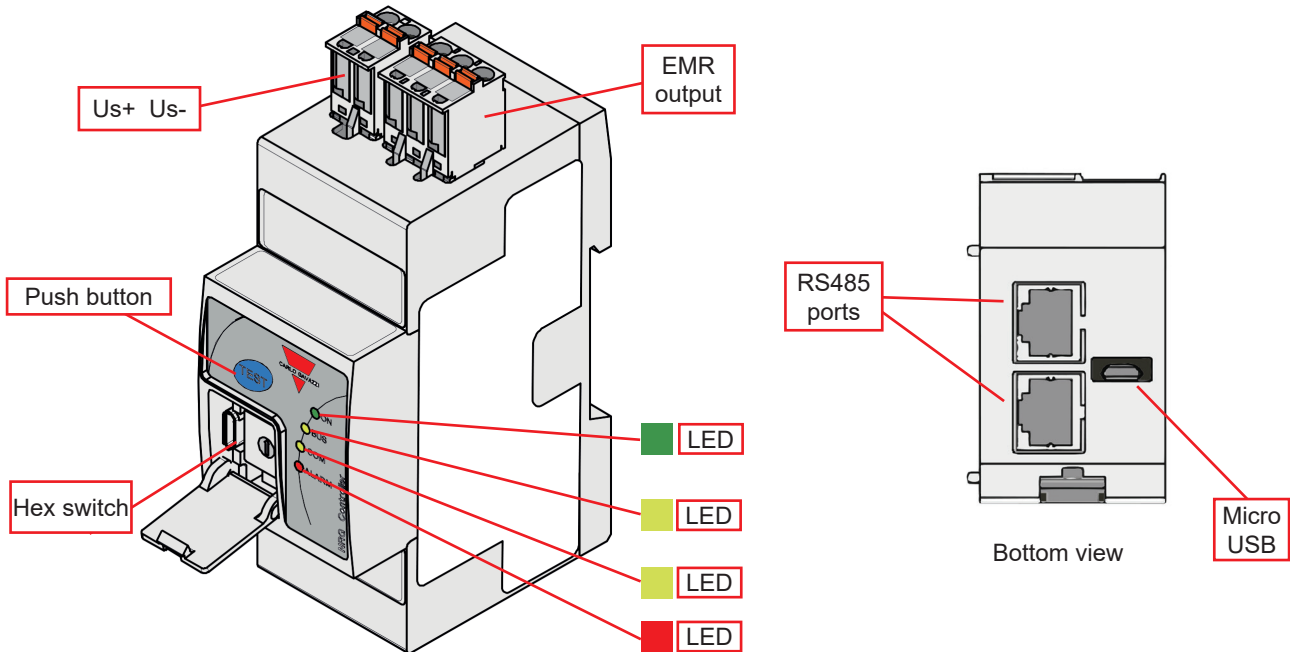

Element	Component	Function
Us+ Us-	Supply connection	2 position spring plug - Us+, Us- connection for powering the NRGC
Push button	Communications check button	Enables and disables a Communications Check function of the BUS chain (link between NRGC and RG..Ns) by pressing front button between 2 to 5 seconds
Hex Switch	NRGC ID hex switch	Sets ID 1 to 15 of the NRGC through a hex switch located behind a door flap that can be opened by a flat screwdriver. Default shipping position = 0 (i.e., internal NRGC ID = 1)
EMR output	Auxiliary Electromechanical relay	3 position electromechanical relay (11, 12, 14) that can function as an Alarm EMR or a general purpose EMR Default shipped function = Alarm EMR
Green LED	ON indicator	Indicates presence of Supply voltage on NRGC
Yellow LED	BUS indicator	Indicates ongoing communication with RG..Ns
Yellow LED	COM indicator	Indicates ongoing communication with main controller
Red LED	ALARM indicator	Indicates presence of an Alarm condition
RS485 ports	RS485 internal communication ports	2x RJ45 (loopable) plugs for RS485 communications line
Micro USB	Micro-USB port – internal BUS	RCRGN cable connection for the internal BUS communications line

Features

General data

Material	Noryl (UL94 V0), RAL7035
Mounting	DIN rail
Dimensions	2-DIN
Touch protection	IP20, IP00 with door flap on front facade open
Weight	135 g
Compatibility	NRGC RGC1A60D...N solid state contactors (RG end-devices) RGS1A60D...N solid state relays (RG end-devices)

Dimensions

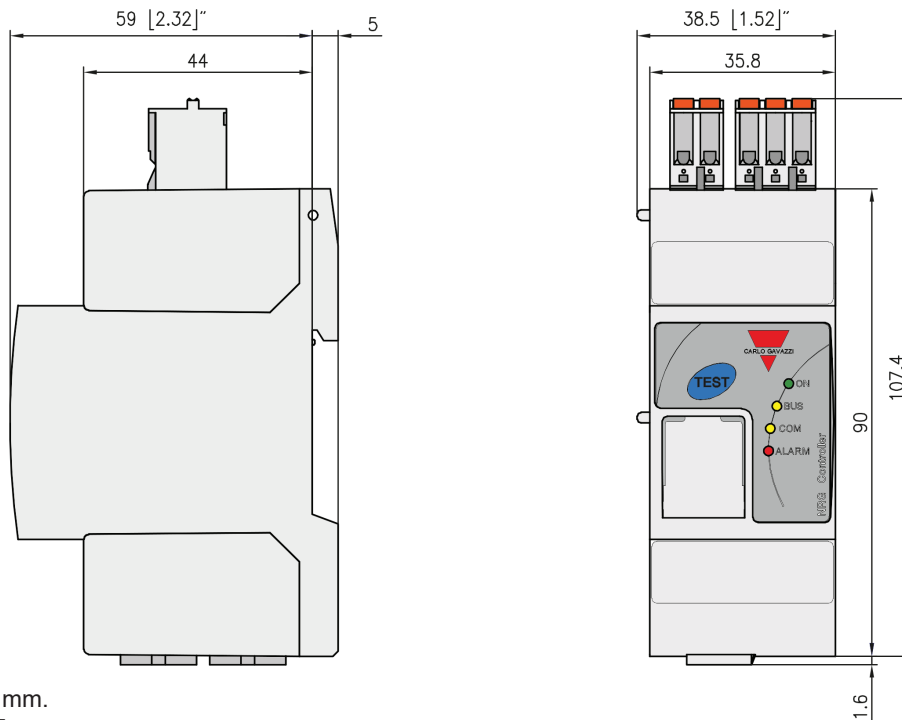

All dimensions in mm.
Tolerances +/- 0.5 mm.

Performance

Power supply specifications

Supply port rating, Us	24 VDC
Supply voltage range, Us	19.2 – 32 VDC*
Reverse polarity protection	Yes
Consumption	< 5W
LED Indication, Supply ON	Green LED
Power on, Power off delay	<500ms. No messages are accepted during this time

* to be supplied by class 2 power source according to UL1310

Auxiliary relay specifications

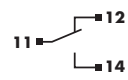
Function	<p>Alarm EMR (default setting): operates in case of an Alarm condition present on the NRGC or</p> <p>General Purpose EMR: operation controlled through ModBus</p> <p>This is configurable via the Relay Configuration Register - refer to NRG User Manual for further details</p>
Output type	<p>EMR, 1 Form C</p> <p>Normally closed (11-12)</p> <p>Normally open (11-14)</p> 
Contact rating	2A @ 250 VAC/30 VDC
Isolation	11, 12, 14 to Us: 1.5k VAC



RS485

Communication protocol to Main Controller	ModBus RTU
Type	2-wire, half duplex
NRGC typology	<ul style="list-style-type: none"> - ModBus slave using standard Modbus function codes - Byte repeater when main controller addresses RG..Ns directly through the use of a special function code
Baud rate	<p>Default: 115200 bits/s</p> <p>Selectable via ModBus: 9600, 19200, 38400, 57600 and 115200 bits/s</p>
Data Format	<p>Data bits: 8</p> <p>Parity: Even (Default)</p> <p>Stop bit: 1</p> <p>Selectable via ModBus: Even, Odd, No parity</p>
Address	<p>Default: 1 (Hex switch position 0)</p> <p>Selectable: 1 to 15 via hex switch</p> <p>Selectable: 1 to 247 via Modbus (with Hex switch position set to 0)</p>
Max. number of NRGCs in the system	247
Connection to main controller	<p>2x shielded RJ45 plugs;</p> <p>1 plug for interfacing to PLC / main controller</p> <p>1 plug for looping to another NRGC</p>
LED indication - COM	Yellow, ON indicating ongoing communication with the main controller

Internal Bus

Max. number of RG..Ns connected to NRGC	48
Connection to RG..Ns	RCRGN-xx 5-way cable terminated with micro-USB connection
BUS termination	RGN-TERMRES (1x pc. provided with 1x NRGC) to be plugged on the last RG..N on the BUS chain to terminate the internal BUS
LED indication - BUS	Yellow, ON indicating ongoing communication with the RG end-devices

Compatibility and Conformance

Approvals (pending)	  
Standards compliance	LVD: EN 60947-5-1 EMC: EN 60947-5-1 UL: UL508, E172877, NMFT cUL: C22.2 No. 14-13, E172877, NMFT7

Electromagnetic compatibility (EMC) - Immunity	
Electrostatic discharge (ESD)	EN/IEC 61000-4-2 8 kV air discharge, 4 kV contact (PC1)
Radiated radio frequency	EN/IEC 61000-4-3 10 V/m, from 80 MHz to 1 GHz (PC1) 10 V/m, from 1.4 to 2 GHz (PC1) 3 V/m, from 2 to 2.7 GHz (PC1)
Electrical fast transient (burst)	EN/IEC 61000-4-4 Output: 2 kV, 5 kHz & 100 kHz (PC1) Input: 1 kV, 5 kHz & 100 kHz (PC1)
Conducted radio frequency	EN/IEC 61000-4-6 10V/m, from 0.15 to 80 MHz (PC1)
Electrical surge	EN/IEC 61000-4-5 DC Output / Input, line to line: 500 V (PC2) DC Output / Input, line to earth: 500 V (PC2) Signal, line to earth 1 kV (PC2) ⁶
Voltage dips and interruptions	EN/IEC 61000-4-11 0% @ 5000ms (PC2) 40% @ 200ms (PC2) 60% @ 10, 30, 100, 300, 1000ms (PC2)
Voltage dips and interruptions on input lines	EN/IEC 61000-4-29 0% @ 1, 3, 10, 30, 100, 300, 1000ms (PC2) 30% @ 10, 30, 100, 300, 1000ms (PC2) 70% @ 10, 30, 100, 300, 1000ms (PC2) 80% @ 10, 30, 100, 300, 1000ms, 3s, 10s (PC2) 120% @ 10, 30, 100, 300, 1000ms, 3s, 10s (PC2)





6. Not applicable to shielded cables <10m. Additional suppression on data lines may be required if shielded cables are not used.

Electromagnetic compatibility (EMC) - Emissions	
Radio interference field emission (radiated)	EN/IEC 55011 Class A: from 30 to 1000 MHz
Radio interference voltage emissions (conducted)	EN/IEC 55011 Class B: from 0.15 to 30 MHz

Environmental specifications

Operating temperature	-20 to +65 °C (-4 to +149 °F)
Storage temperature	-20 to +65 °C (-4 to +149 °F)
Relative humidity	95% non-condensing @ 40°C
Pollution degree	2
Installation altitude	0 - 2000m
EU RoHS compliant	Yes
China RoHS	

LED indicators

ON	Green 	ON:	Us is present at terminals Us+, Us-
		OFF:	Us is not present at terminals Us+, Us-
BUS	Yellow 	ON:	During transmission of messages from NRGC to RG..Ns
		OFF:	Idle bus between the NRGC and RG..Ns and when NRGC is receiving data from RG..Ns
COM	Yellow 	ON:	During transmission of a reply from the NRGC to the main controller
		OFF:	Idle bus between the main controller and NRGC and when NRGC is receiving data from the main controller
ALARM	Red 	ON:	Flashing when alarm condition is present. Refer to Alarm management section
		OFF:	No alarm condition

Alarm management

Alarm condition present	<ul style="list-style-type: none"> • Red LED ON with a specific flashing rate • Any of the error flags in NRG status register (CTRSR) is set • Auxiliary relay operates if: <ul style="list-style-type: none"> - It is set as an Alarm relay (shipped default operation) - Respective alarm bit is not masked in the Relay Configuration Register (RLYCR). Refer to NRG user manual for further details 	
Alarm types	No. of flashes	Description of fault
	2	Configuration Error: The number of RG..Ns connected to the bus chain is not correct <ul style="list-style-type: none"> - The number of RG..Ns on bus chain >48 (Device Limit Error) - The number of RG..Ns on bus chain is not as expected (Device Mismatch Error). This alarm is not generated automatically but can be optionally set by the user
	3	Communication Error (COM): An error in the communication link (RS485) between the main controller and the NRG
	8	Communication Error (BUS): An error in the communication link (internal BUS) between the NRG and RG..Ns
	9	Internal Error: Supply out of range or detection of abnormal conditions
10	Termination (BUS) Error: Internal BUS chain not terminated	
Flashing rate		

Connection diagram

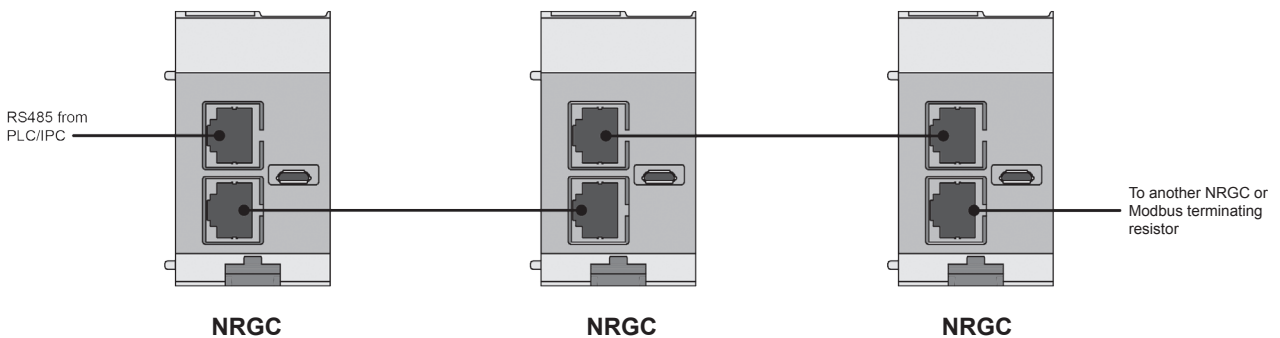

Mounting

Mounting on DIN rail

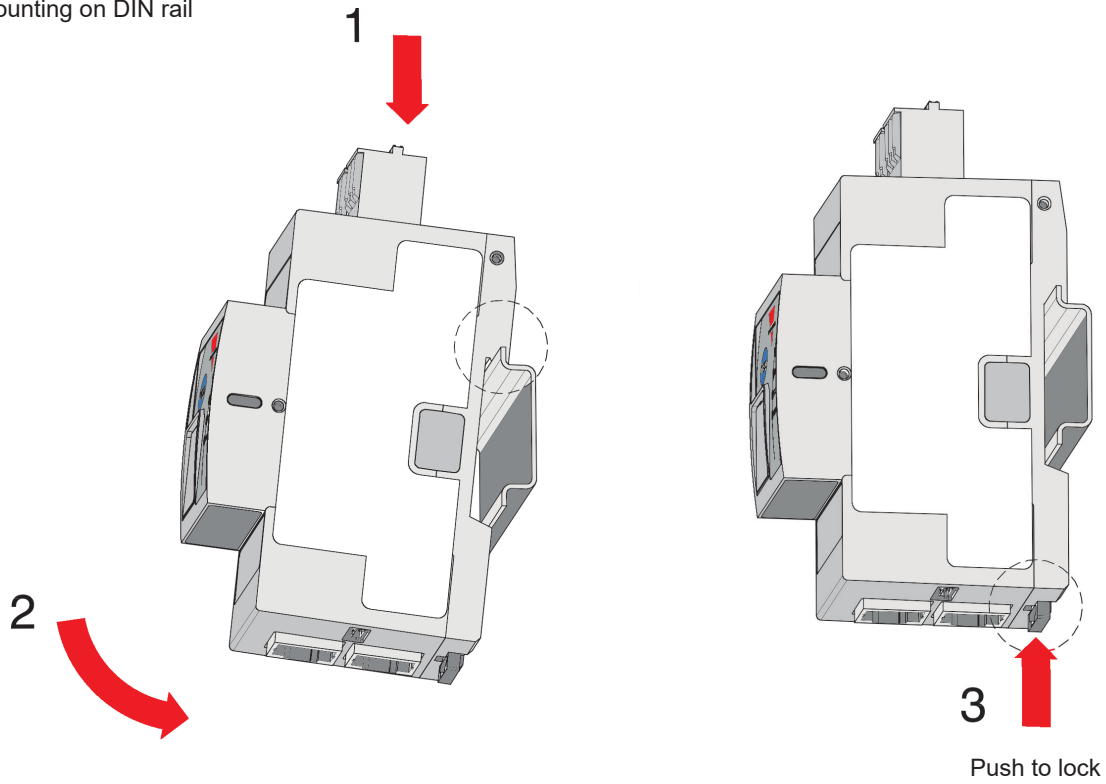

Dismounting from DIN rail

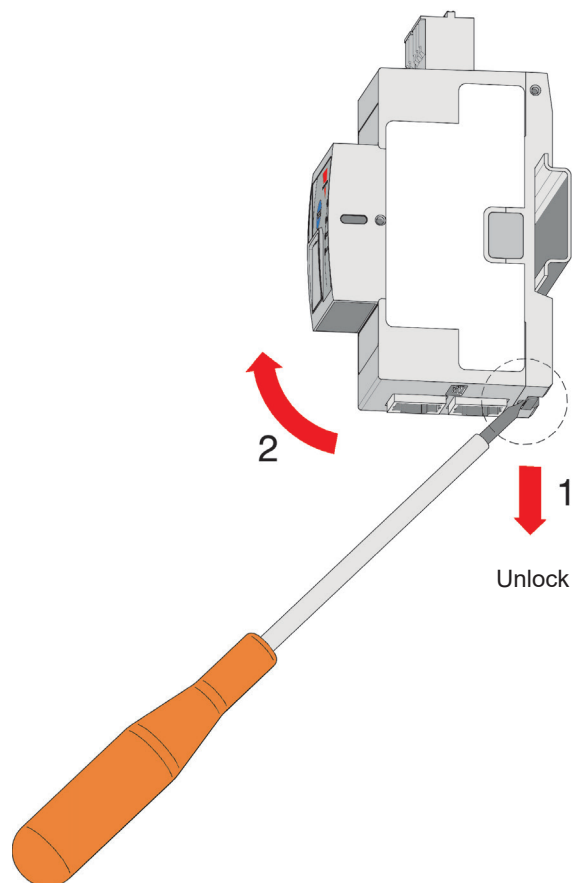

Connection specifications

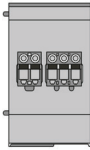
Power connection	
Terminal	Supply: Us+, Us- Auxiliary EMR: 11, 12, 14
	 <p>Top view</p>
Conductors	Use 60/75°C copper (Cu) conductors
Stripping length	12 - 13mm
Connection type	Spring plug, pitch 5.08mm 2-pole for Supply 3-pole for Auxiliary EMR (11 Common, 12 Normally Closed, 14 Normally Open)
Rigid (solid & stranded) UL/CSA rated data	0.2 – 2.5mm ² , 26 – 12 AWG
Flexible with end sleeve	0.25 – 2.5mm ²
Flexible without end sleeve	0.25 – 2.5mm ²
Flexible with end sleeve using TWIN ferrules	0.5 – 1.0mm ²

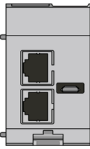
Communication - connection	
Terminal	COM: RJ45 (x2) BUS: RCRGN-xxx-2
	 <p>Bottom view</p>
ModBus RS485 connection	RJ45 shielded plugs, x2 to allow looping
Cable for ModBus	Not provided. Shielded CAT-5e cables are recommended. Connection should be straight, i.e., pin 1 at one end should be connected to pin 1 at the other end. Refer to NRG user manual for further details for the RJ45 connection pin connections.
Max. length of RS485 cable	25 mtrs (this covers the total cable length from the main controller to the last NRG in the ModBus chain)
Cable for Internal Bus	RCRGN-xxx-2: 5-way USB micro connection <ul style="list-style-type: none"> - +24 supply line for RG..Ns - GND - RS485A - RS485B - Autoconfig line

RCRGN..



NRG internal BUS cable



Main features

- Cables available at various lengths to provide the internal BUS of the NRG system
- Cables terminated at both ends with a microUSB plug
- Connects the NRG to the RG..N solid state relay and respective RG..N solid state relays

Description

The **RCRGN** cables are proprietary cables that must be used with the NRG system for the internal BUS. These cables connect the NRG controllers to the RG..N solid state relays and respective RG..N solid state relays.

The RCRGN... are 5-way cables carrying the communication, supply and autocofiguration lines. By means of autoconfiguration, the RG..Ns are assigned a unique ID based on the physical location and hence internal BUS wiring sequence when an autoconfiguration command is sent to the RG..Ns.

Carlo Gavazzi compatible components

Description	Component code	Notes
NRGC controller	NRGC	NRG controller with Modbus RS485. 1x RGN-TERMRES is included in the NRGC packaging
Relays	RG..N	NRG solid state relays

Order code

RCRGN - - 2

Enter the code entering the corresponding option instead of

Code	Option	Description	Notes
R	-	Cables Suitable for the NRG system	
C	-		
R	-		
G	-		
N	-		
<input type="checkbox"/>	010	10cm cable length	packed x 4 pc.
	075	75cm cable length	packed x 1 pc.
	150	150cm cable length	packed x 1 pc.
	350	350cm cable length	packed x 1 pc.
	500	500cm cable length	packed x 1 pc.
2	-	Terminated at the both ends with a microUSB connector	

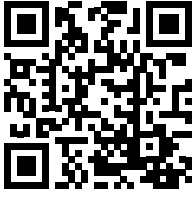

COPYRIGHT ©2018
Content subject to change. Download the PDF: www.productselection.net